



Diesel Product Line

208-600 Volt

BSJD40KWSP

60 Hz / 1800 RPM

40 kWe / 35 kWe

Standby / Prime

Ratings

	240V	208V	240V	480V	600V
Phase	1	3	3	3	3
PF	1.0	0.8	0.8	0.8	0.8
Hz	60	60	60	60	60
Generator Model	361CSL1601	361CSL1600	361CSL1600	361CSL1600	361PSL1632
Connection	12 LEAD ZIG-ZAG	12 LEAD WYE	12 LEAD DELTA	12 LEAD WYE	4 LEAD WYE
Standby					
kWe	40	40	40	40	40
AMPS	167	139	120	60	48
Temp Rise	105°C / 40°C	105°C / 40°C	105°C / 40°C	105°C / 40°C	105°C / 40°C
Prime [Only Available For Mobile Applications]					
kWe	35	35	35	35	35
AMPS	146	122	105	53	42
Temp Rise	105°C / 40°C	105°C / 40°C	105°C / 40°C	105°C / 40°C	105°C / 40°C

Standard Equipment

- | | | |
|---|--|---|
| <p>Engine</p> <ul style="list-style-type: none"> ▶ Radiator Cooled Unit Mounted (50°C) ▶ Blower Fan & Fan Drive ▶ Starter & Alternator ▶ Oil Pump & Filter ▶ Oil Drain Extension w/Valve ▶ Governor - Electronic Isochronous ▶ 12V Battery System & Cables ▶ Air Cleaner (Dry Single Stage) ▶ Flexible Fuel Connector ▶ EPA Certified Tier 3 <p>Listing Certifications</p> <ul style="list-style-type: none"> ▶ UL 2200 Listed ▶ cUL Listed ▶ CSA Certified ▶ Seismic Certified to IBC 2012 | <p>Generator</p> <ul style="list-style-type: none"> ▶ Brushless Single Bearing ▶ Automatic Voltage Regulator ▶ ± 1% Voltage Regulation ▶ 4 Pole, Rotating Field ▶ 105°C Standby Temperature Rise ▶ 105°C Prime Temperature Rise ▶ 100% of Rated Load - One Step ▶ 5% Maximum Harmonic Content ▶ NEMA MG 1, IEEE and ANSI Standards Compliance for Temperature Rise | <p>Additional</p> <ul style="list-style-type: none"> ▶ Microprocessor Based Digital Control ▶ Interface Connection Box ▶ Control Panel Mounted in NEMA 12 Enclosure ▶ Base - Formed Steel ▶ Main Line Circuit Breaker Mounted & Wired ▶ Critical Grade Silencer Mounted ▶ Battery Charger 12V 6 Amp ▶ Jacket Water Heater -20°F 1500W 120V w/Isolation Valves ▶ Vibration Isolation Mounts ▶ Radiator Duct Flange (OPU Only) ▶ Single Source Supplier ▶ 2YR / 2000HR Standby Warranty ▶ 1YR / 1500HR Prime Warranty ▶ Standard Colors - White / Tan / Gray |
|---|--|---|

Diesel Product Line



POWERDAK
POWER PRODUCTS, LLC

BSJD40KWSP
40 kWe / 35 kWe

Application Data

Engine			
Manufacturer:	John Deere	Displacement - Cu. In. (lit):	275 (4.50)
Model:	4045TF280	Bore - in. (cm) x Stroke - in. (cm):	4.19 (10.6) x 5.00 (12.7)
Type:	4-Cycle	Compression Ratio:	19.0:1
Aspiration:	Turbo Charged	Rated RPM:	1800
Cylinder Arrangement:	4 Cylinder Inline	Max HP Stby (kWm):	75.0 (56.0)

Exhaust System	Standby	Prime
Gas Temp. (Stack): °F (°C)	945 (507)	918 (492)
Gas Volume at Stack Temp: CFM (m³/min)	448 (12.7)	424 (12.0)
Maximum Allowable Exhaust Restriction: in. H ₂ O (kPa)	30.0 (7.50)	30.0 (7.50)
Cooling System		
Ambient Capacity of Radiator: °F (°C)	122 (50.0)	122 (50.0)
Maximum Allowable Static Pressure on Rad. Exhaust: in. H ₂ O (kPa)	0.50 (0.12)	0.50 (0.12)
Water Pump Flow Rate: GPM (lit/min)	38.0 (144)	38.0 (144)
Heat Rejection to Coolant: BTUM (kW)	1,821 (31.9)	1,707 (29.9)
Heat Radiated to Ambient: BTUM (kW)	512 (9.00)	448 (7.80)
Air Requirements		
Aspirating: CFM (m³/min)	180 (5.09)	173 (4.90)
Air Flow Required for Rad. Cooled Unit: CFM (m³/min)	4,760 (135)	4,760 (135)
Air Flow Required for Heat Exchanger/Rem. Rad. CFM (m³/min)	Consult Factory For Remote Cooled Applications	
Fuel Consumption		
At 100% of Power Rating: gal/hr (lit/hr)	4.13 (15.6)	3.82 (14.4)
At 75% of Power Rating: gal/hr (lit/hr)	3.25 (12.3)	2.99 (11.3)
At 50% of Power Rating: gal/hr (lit/hr)	2.21 (8.37)	2.11 (8.00)
Fluids Capacity		
Total Oil System: gal (lit)	3.88 (14.7)	3.88 (14.7)
Engine Jacket Water Capacity: gal (lit)	2.25 (8.52)	2.25 (8.52)
System Coolant Capacity: gal (lit)	5.38 (20.4)	5.38 (20.4)

Deration Factors

Rated Power is available up to 10,000 ft (3,048 m) at ambient temperatures to 122°F (50°C) standby and prime.
Consult factory for site conditions above these parameters.

Diesel Product Line



POWERDAK
POWER PRODUCTS, LLC

BSJD40KWSP
40 kWe / 35 kWe

DGC-2020 Control Panel

Standard Features

- ▶ Digital Metering
- ▶ Engine Parameters
- ▶ Generator Protection Functions
- ▶ Engine Protection
- ▶ CAN Bus ECU Communications
- ▶ Windows-Based Software
- ▶ Multilingual Capability
- ▶ Remote Communications to RDP-110 Remote Annunciator
- ▶ 16 Programmable Contact Inputs
- ▶ Up to 15 Contact Outputs (7 standard)
- ▶ UL Recognized, CSA Certified, CE Approved
- ▶ Event Recording
- ▶ IP 54 Front Panel Rating with Integrated Gasket
- ▶ NFPA 110 Level 1 Compatible

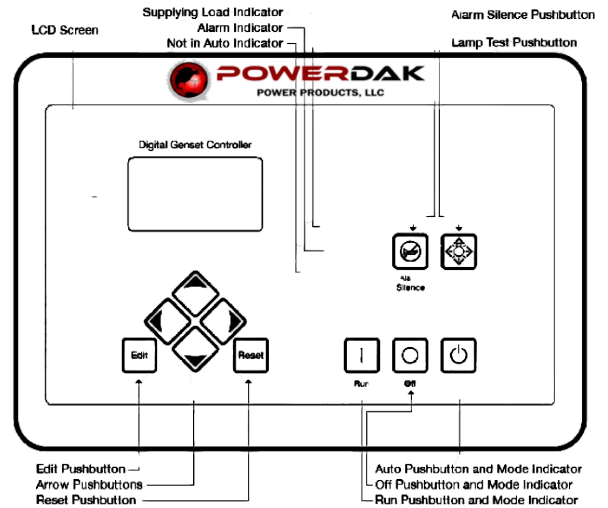

Weights / Dimensions / Sound Data

	L x W x H	Weight lbs
OPU	80 x 38 x 58 in	1,950
Level 1	90 x 38 x 60 in	2,425
Level 2	90 x 38 x 60 in	2,475
Level 3	120 x 38 x 60 in	2,625

Please allow 6-12 inches for height of exhaust stack.

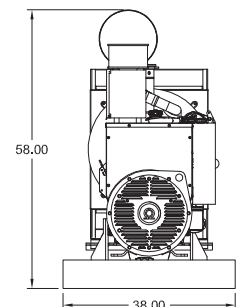
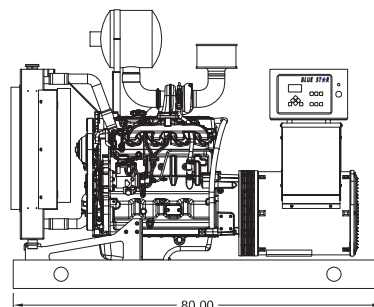
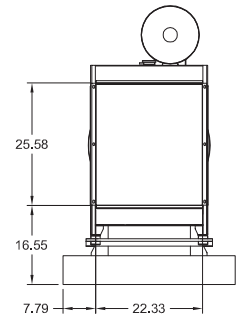
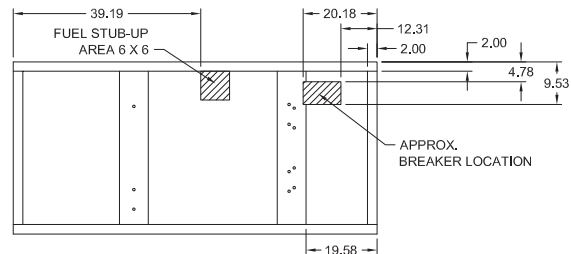

Drawings based on standard open power 480 volt standby generator. Lengths may vary with other voltages. Subject to change without notice. Sound data as measured at 23 feet (7 meters) in accordance with ISO 8528-10 at standby rating.

BSJD40KWSP
40 kWe / 35 kWe

Diesel Product Line

BSJD40KWSP
40 kWe / 35 kWe



POWERDAK
 POWER PRODUCTS, LLC

Enclosures

Level 1 & 2 | Side View (Weather Proof)

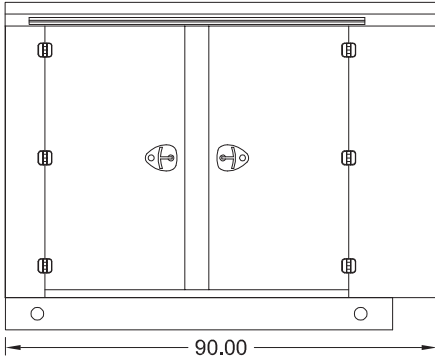

Level 3 | Side View (Sound Attenuated)

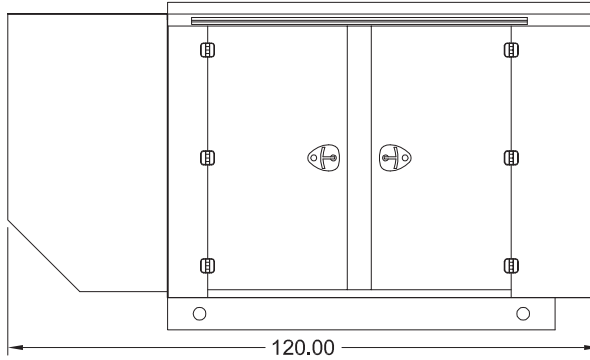

Level 1, 2 & 3 | Intake View

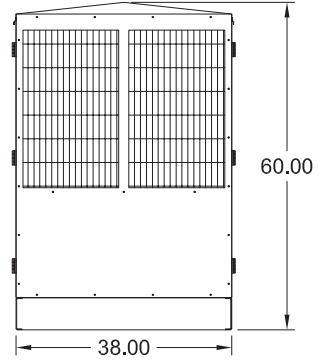

All enclosures are 150 MPH Wind Rated.

Level 2 & 3 enclosures include sound attenuation foam.

Level 3 enclosure includes frontal sound & exhaust hood.

*Enclosure height does not include exhaust stack.

Double Wall UL 142 Listed Fuel Tanks

Side View

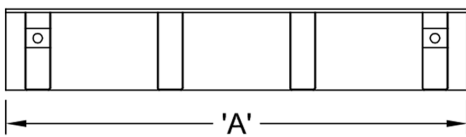

Rear View

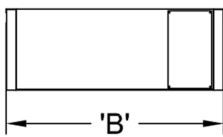

	24 Hour 120 Gallon	48 Hour 240 Gallon	72 Hour 360 Gallon
A	80.00	80.00	108.00
B	38.00	38.00	38.00
C	20.00	36.00	36.00

All specification sheet dimensions are represented in inches.

All enclosures and fuel tanks are based on the standard standby unit configuration. Any deviation can change dimensions. Materials and specifications subject to change without notice.

Powerdak Power Products - 3350 Jet Drive, Rapid City, South Dakota 57703 - 605.341.6160 Ext 1 - Fax 605.718.9998
 e-mail: dave@dakgenerator.com

American Owned



American Made

BSJD40KWSP 40
kWe / 35 kWe